

Oscillator · JO22H · 3.3 V



actual size

High Stability Oscillator with Stop Function · 2.5 x 2.0 mm

- low cost high stability SMD oscillator
- stability meets spec for WiMax and WLAN
- RoHS compliant, ceramic/metal package
- reflow soldering temperature: 260 °C max.



General Data

type		JO22H 3.3V
frequency range		4.0 ~ 54.0 MHz (15pF max.)
frequency stability over all*		± 10ppm ~ ± 20ppm (table 1)
current consumption		7 mA max.
supply voltage V _{DC}		3.3 V ±5%
temperature	operating	-20°C ~ +70°C / -40°C ~ +85°C
	storage	-40°C ~ +85°C
output	rise & fall time	5 nsec max.
	load max.	15pF
	current max.	4 mA
	low level max.	0.1 x V _{DC}
	high level min.	0.9 x V _{DC}
output enable time max.		10 ms
output disable time max.		250ns
start-up time max.		10 ms
standby function		stop
standby current max.		10 µA
jitter		< 3.0 ps RMS typ.
symmetry at 0.5 x VDC		45% ~ 55% max.

Table 1: Frequency Stability Code

stability code	D ± 20 ppm	E ± 15 ppm	F ± 10 ppm		
-20 °C ~ +70 °C	○	○	○		
-40 °C ~ +85 °C	○	○	○		
○ available					

* includes stability at 25°C, operating temp. range, supply voltage change, load change, vibration, aging 1st year

Table 2: Rise & Fall Time max.

5 ns: 4.0 ~ 54.0 MHz	note: - specific data on request - rise time: 0.1 V _{DC} ~ 0.9 V _{DC} - fall time: 0.9 V _{DC} ~ 0.1 V _{DC}
----------------------	--

Enable / Disable Function

pin #1 (e/d control)	pin #3 (output)
open	active
high "1" (V _{IH} ≥ 0.7 V _{DC})	active
low "0" (V _{IL} ≤ 0.3 V _{DC})	high impedance
stop function: • oscillator stops / • output high impedance	

Dimensions

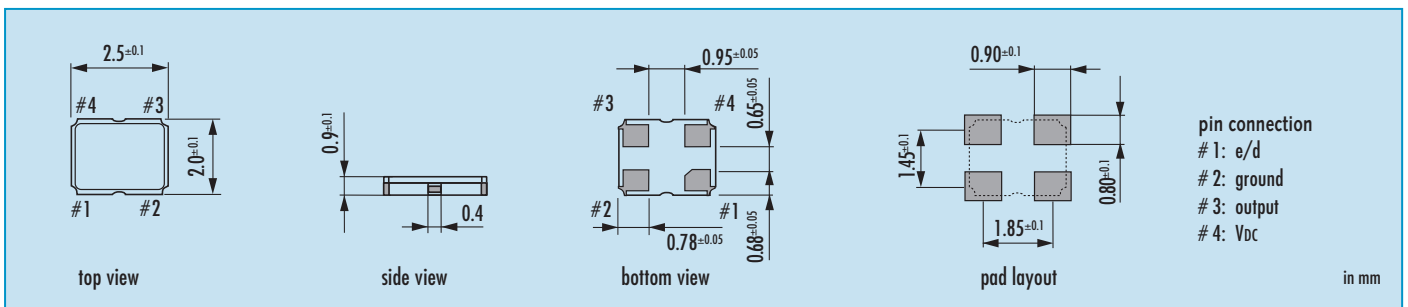

Order Information

0	frequency	type	frequency stability code	supply voltage code	output load code	option
Oscillator	4.0 ~ 54.0 MHz	JO22H	see table 1	3.3 = 3.3 V	1 = 15 pF	blank = -20°C ~ +70°C T1 = -40°C ~ +85°C

Example: O 20.0-JO22H-F-3.3-1-T1 (LF = RoHS compliant / Pb free pins or pads)

Oscillator · JO22H · 3.3 V · Low Power

Taping Specification

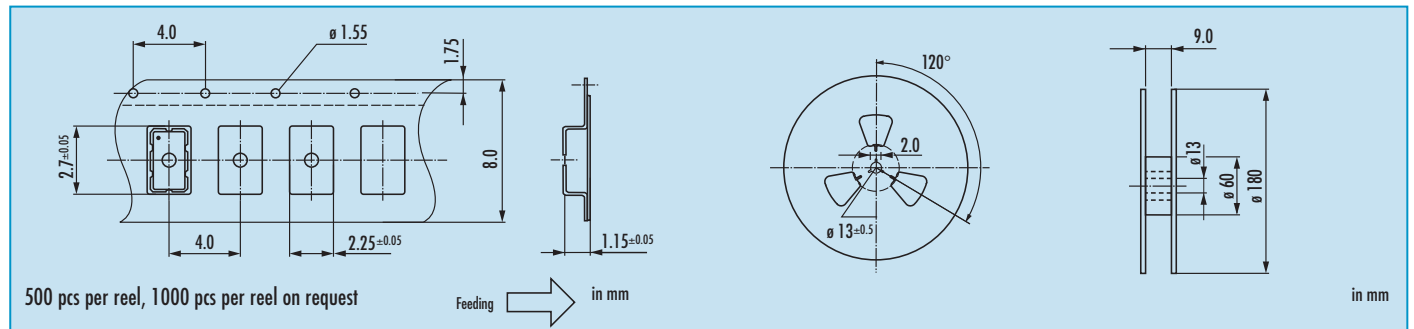

Reflow Soldering Profile

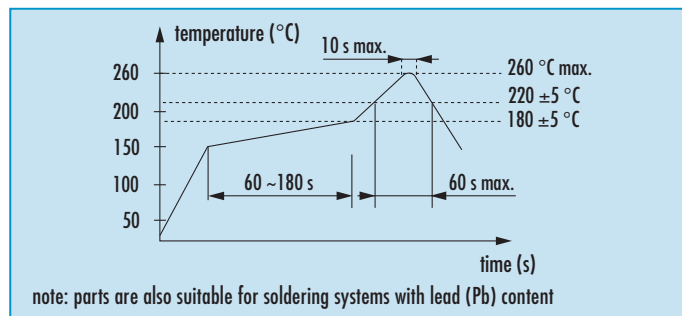

Marking

frequency
company code / stability code / date code

date code:

Jan.	Febr.	Mar.	Apr.	May	June
A	B	C	D	E	F
July	Aug.	Sept.	Oct.	Nov.	Dec.
G	H	J	K	L	M

A ~ M: Jan. - Dec.
0: 2010 3: 2013
1: 2011 4: 2014
2: 2012 5: 2015

Packing Note

- standard packing units are 500 pieces per reel
- non-multiple packing units are only supplied taped / bulk